

TECHNICAL SPECIFICATIONS

- GPA COLUMNS, POLES AND MASTS ARE SPECIFICALLY DESIGNED AND ENGINEERED FOR THE VARIOUS AUSTRALIAN WIND SPEED, TERRAIN AND TOPOGRAPHIC CONDITIONS.
- GPA COLUMNS, POLES AND MASTS ARE MANUFACTURED IN COMPLIANCE TO AUSTRALIAN STANDARD AS/NZS 1170
- MATERIALS USED FOR LIGHTING COLUMNS ARE IN COMPLIANCE TO AS/NZS 4600.
- LIGHTING COLUMNS ARE LONGITUDINALLY SEAM WELDED CONFORM TO AUSTRALIAN STANDARDS BY AUTOMATIC CONTINUOUS METAL INERT GAS (MIG) PROCESS.
- COLUMNS ARE ANTI-CORRODED BY HOT-DIP GALVANISED, COMPLIANCE TO GALVANIZING STANDARD AS4680
- SERVICE DOOR DIMENSIONS ARE GIVEN AS A GUIDE ONLY. THE ENGINEER MUST SATISFY HIMSELF THAT DIMENSIONS GIVEN ARE ADEQUATE FOR THE INSTALLATION OF THE REQUIRED CONTROL GEAR.
- ALL DIMENSIONS ARE IN (mm), UNLESS OTHERWISE SPECIFIED.

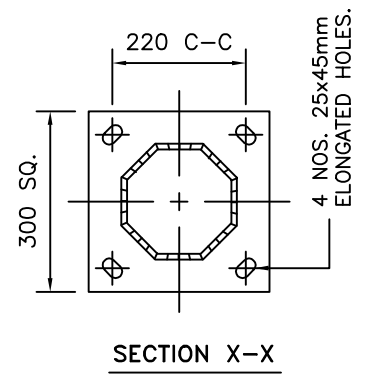
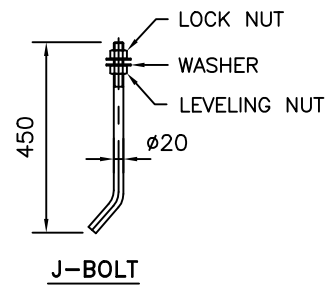
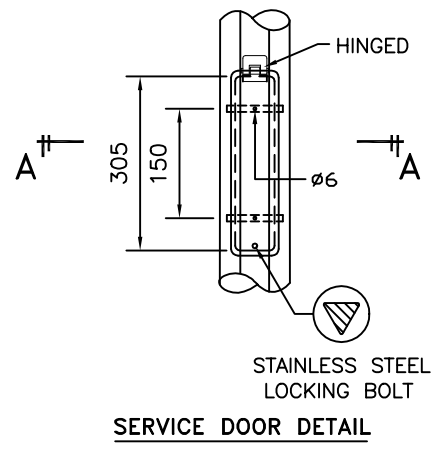
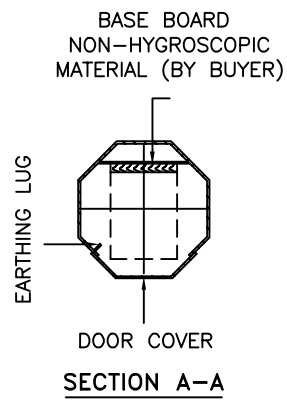
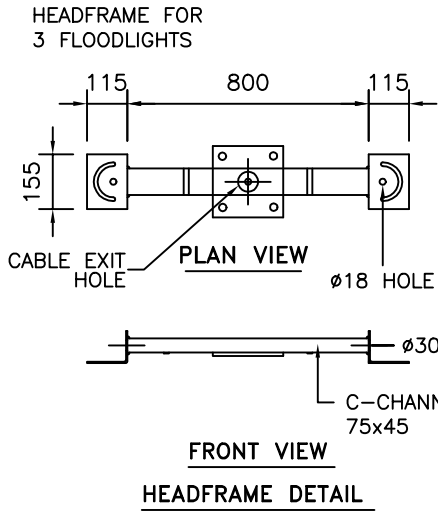
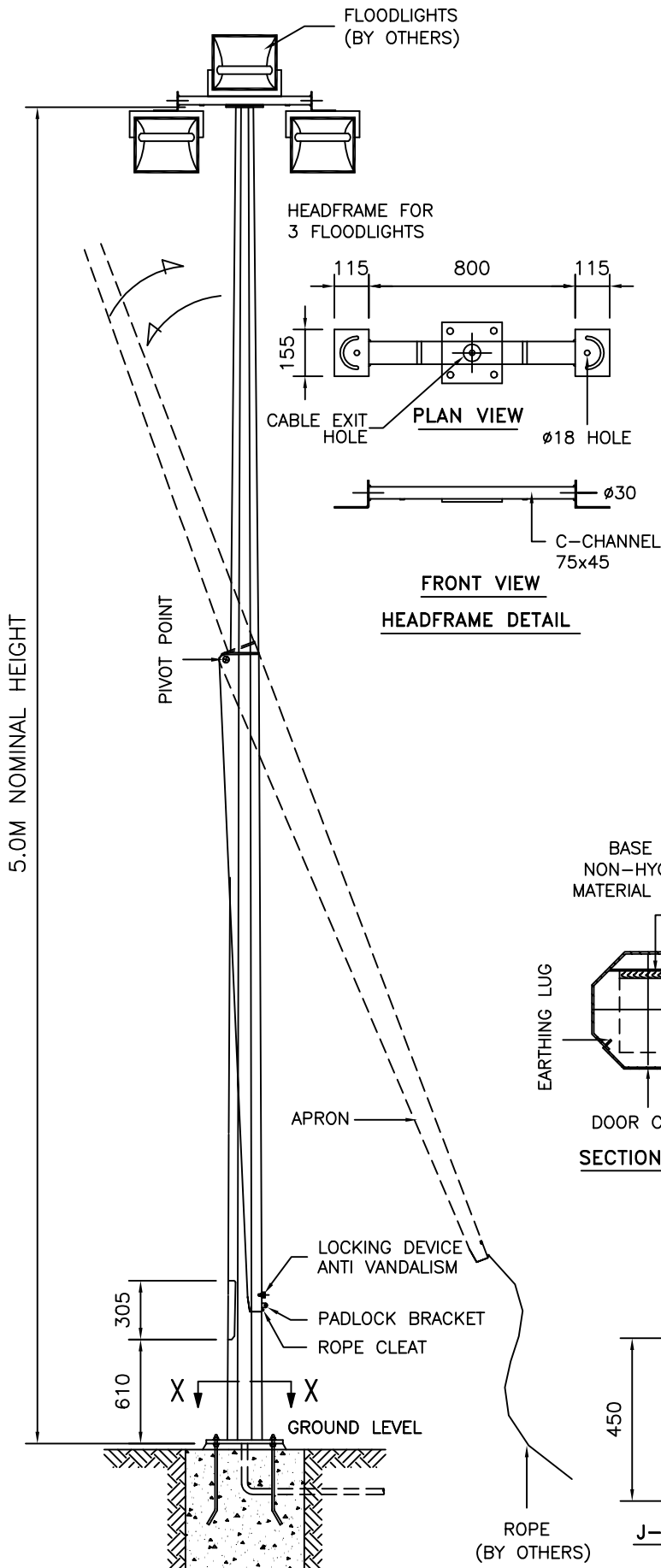

GALVANISED POLES AUSTRALIA
 45 Briggs Street, Welshpool,
 Western Australia 6106
 P: 1300 790 343
 E: sales@galvanisedpolesaustralia.com
 www.galvanisedpolesaustralia.com

CLIENT : -	DRAW NO : 5M/FLCHC/HF-3/FM/01/RO		
PROJECT : -	FILE NAME : FLCHC ISO STD		
DATE : 27-03-2010	DRAWN BY : D.C.	INCHARGE BY : D.C.	SCALE : N.T.S
DRAWING TITLE : 5M MID-HINGED COLUMN HEADFRAME 3		CHECK/APPR. BY : D.C.	A4 SIZE
THIS DRAWING IS THE PROPERTY OF GALVANISED POLES AUSTRALIA AND MUST NOT BE REPRODUCED WITHOUT THEIR PRIOR CONSENT IN WRITING.			