

**TECHNICAL SPECIFICATIONS**

- GPA COLUMNS, POLES AND MASTS ARE SPECIFICALLY DESIGNED AND ENGINEERED FOR THE VARIOUS AUSTRALIAN WIND SPEED, TERRAIN AND TOPOGRAPHIC CONDITIONS.
- GPA COLUMNS, POLES AND MASTS ARE MANUFACTURED IN COMPLIANCE TO AUSTRALIAN STANDARD AS/NZS 1170
- MATERIALS USED FOR LIGHTING COLUMNS ARE IN COMPLIANCE TO AS/NZS 4600.
- LIGHTING COLUMNS ARE LONGITUDINALLY SEAM WELDED CONFORM TO AUSTRALIAN STANDARDS BY AUTOMATIC CONTINUOUS METAL INERT GAS (MIG) PROCESS.
- COLUMNS ARE ANTI-CORRODED BY HOT-DIP GALVANISED, COMPLIANCE TO GALVANIZING STANDARD AS4680
- SERVICE DOOR DIMENSIONS ARE GIVEN AS A GUIDE ONLY. THE ENGINEER MUST SATISFY HIMSELF THAT DIMENSIONS GIVEN ARE ADEQUATE FOR THE INSTALLATION OF THE REQUIRED CONTROL GEAR.
- ALL DIMENSIONS ARE IN (mm), UNLESS OTHERWISE SPECIFIED.

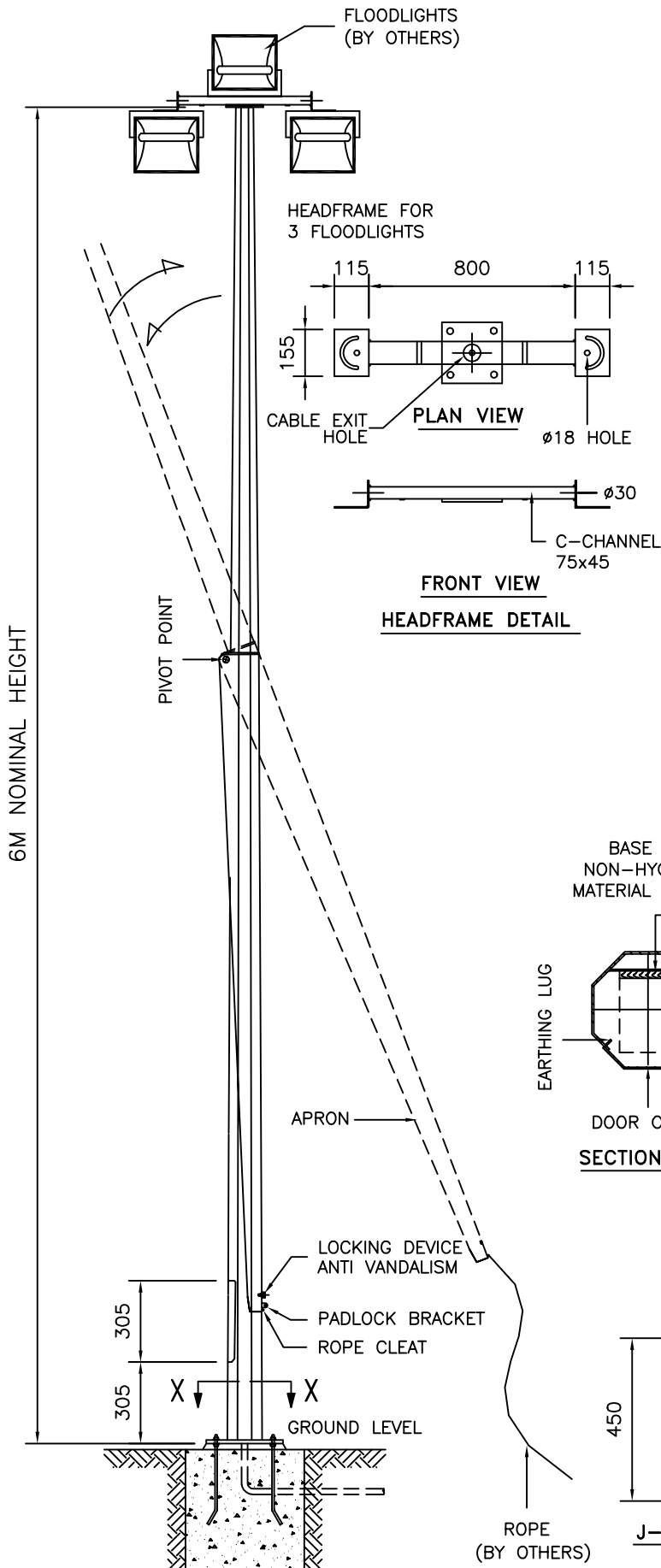

BASE BOARD  
NON-HYGROSCOPIC  
MATERIAL (BY BUYER)

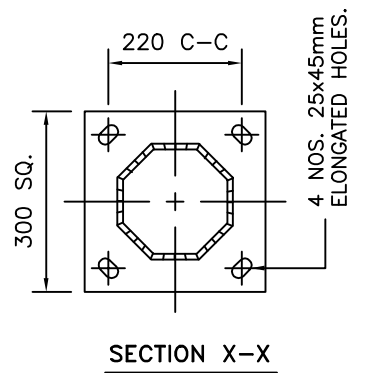
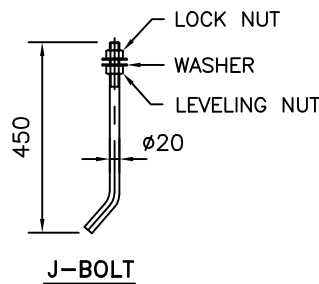
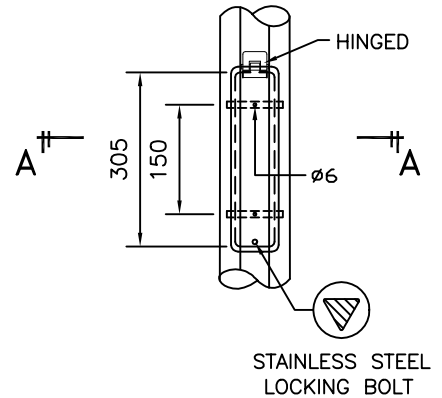
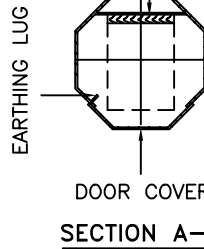

**GALVANISED POLES AUSTRALIA**  
45 Briggs Street, Welshpool,  
Western Australia 6106  
P: 1300 790 343  
E: sales@galvanisedpolesaustralia.com  
www.galvanisedpolesaustralia.com

CLIENT : -	DRAW NO : 6M/FLCHC/HF-3/FM/01/RO	
PROJECT : -	FILE NAME : FLCHC ISO STD	
DATE : 27-03-2010	DRAWN BY : D.C.	INCHARGE BY : D.C. SCALE : N.T.S
DRAWING TITLE : <b>6M MID-HINGED COLUMN HEADFRAME 3</b>		CHECK/APPR. BY : D.C. A4 SIZE
THIS DRAWING IS THE PROPERTY OF GALVANISED POLES AUSTRALIA AND MUST NOT BE REPRODUCED WITHOUT THEIR PRIOR CONSENT IN WRITING.		